

INSTYTUT TECHNIKI BUDOWLANEJ
PL 00-611 WARSZAWA
ul. FILTROWA 1
tel.: (48 22) 825-04-71;
(48 22) 825-76-55;
fax: (48 22) 825-52-86;
www.itb.pl



Członek EOTA

European Technical Approval

ETA-10/0103

(English language translation – the original version is in Polish language)

Nazwa handlowa

Trade name

TECFI DGE02 do kotwienia prętów zbrojeniowych

TECFI DGE02 for rebar connections

Właściciel aprobaty

Holder of approval

Tecfi S.p.A.

**81050 Pastorano (CE) – S.S. Appia Km 193,
Italy**

Rodzaj i przeznaczenie wyrobu

*Generic type and use
of construction products*

**Wklejane zakotwienia prętów zbrojeniowych
o średnicach od 8 do 32 mm z zastosowaniem
zaprawy iniekcyjnej TECFI DGE02**

*Post-installed rebar connections of the sizes 8 to 32 mm
with TECFI DGE02 injection mortar*

Termin ważności

Valid

od

from

22. 03. 2010

do

to

29. 09. 2014

Zakład produkcyjny

Manufacturing plant

Tecfi Plant 1

**Niniejsza Europejska
Aprobata Techniczna zawiera**

*This European Technical
Approval contains*

23 strony, w tym 12 Załączników

23 pages including 12 Annexes



Europejska Organizacja ds. Aprobatach Technicznych

European Organisation for Technical Approvals

I LEGAL BASES AND GENERAL CONDITIONS

1. This European Technical Approval is issued by Instytut Techniki Budowlanej in accordance with:
 - Council Directive 89/106/EEC of 21 December 1988 on the approximation of laws, regulations and administrative provisions of Member States relating to construction products¹, amended by the Council Directive 93/68/EEC of 22 July 1993²;
 - ustawa z dnia 16 kwietnia 2004 r. o wyrobach budowlanych (law on construction products from 16th April 2004)³;
 - rozporządzenie Ministra Infrastruktury z dnia 14 października 2004 r. w sprawie europejskich aprobat technicznych oraz polskich jednostek organizacyjnych upoważnionych do ich wydawania (regulation of the Ministry of Infrastructure of 14th October 2004 on the European Technical Approvals and Polish bodies entitled to issue them)⁴;
 - Common Procedural Rules for Requesting, Preparing and the Granting of European Technical Approvals set out in the Annex of Commission Decision 94/23/EC⁵;
 - Guideline for European Technical Approval of “*Metal anchors for use in concrete – Part 5: Bonded anchors*”, ETAG 001-05;
2. Instytut Techniki Budowlanej is authorized to check whether the provisions of this European Technical Approval are met. Checking may take place in the manufacturing plant. Nevertheless, the responsibility for the conformity of the products to the European Technical Approval and for their fitness for the intended use remains with the holder of the European Technical Approval.
3. This European Technical Approval is not to be transferred to manufacturers or agents of manufacturers other than those indicated on page 1, or manufacturing plants other than those indicated on page 1 of this European Technical Approval.
4. This European Technical Approval may be withdrawn by Instytut Techniki Budowlanej, in particular after information by the Commission on the basis of Article 5(1) of Council Directive 89/106/EEC.
5. Reproduction of this European Technical Approval including transmission by electronic means shall be in full. However, partial reproduction can be made with the written consent of Instytut Techniki Budowlanej. In this case partial reproduction has to be designated as such. Texts and drawings of advertising brochures shall not contradict or misuse the European Technical Approval.
6. The European Technical Approval is issued by the approval body in its official language. This version corresponds to the version circulated within EOTA. Translations into other languages have to be designated as such.

¹ Official Journal of the European Communities № L 40, 11.02.1989, p. 12

² Official Journal of the European Communities № L 220, 30.08.1993, p. 1

³ Official Journal of Polish Republic № 92/2004, pos. 881

⁴ Official Journal of Polish Republic № 237/2004, pos. 2375

⁵ Official Journal of the European Communities № L 17, 20.01.1994, p. 34

II SPECIFIC CONDITIONS OF THE EUROPEAN TECHNICAL APPROVAL

1 Definition of product and intended use

1.1 Definition of product

The subject of this approval are the post-installed connections, by anchoring or overlap connection joint consisting of steel reinforcing bars (rebars) in existing structures made of normal weight concrete, using injection mortar TECFI DGE02 in accordance with the regulations for reinforced concrete construction.

The design of the post-installed rebar connections shall be done in accordance with EN 1992-1-1 (Eurocode 2).

Reinforcing bars with diameters from 8 to 32 mm and TECFI DGE02 injection mortar according to Annex 4 are used for the post-installed rebar connections covered by this ETA. The steel element is placed into a drilled hole previously injected with a mortar and is anchored by the bond between embedded element, injection mortar and concrete.

1.2 Intended use

The post-installed rebar connections may be used in normal weight concrete of a minimum grade C12/15 and maximum grade C50/60 according to EN 206-1. They may be used in non-carbonated concrete with the allowable chloride content of 0,20% (Cl 0,20) related to the cement content according to EN 206-1.

The rebar connections may be used for predominantly static loads.

Fatigue, dynamic or seismic loading of post-installed rebar connections are not covered by this ETA.

The fire resistance of the post-installed rebar connections is not covered by this ETA.

The rebar connections may only be carried out in the manner, which is also possible with reinforcing bars, e.g. those in the following applications:

- an overlapping joint with existing reinforcement in a building component (Figures 1 and 2, Annex 2),
- anchoring of the reinforcement at a slab or beam support (Figure 3, Annex 2; end support of a slab, designed as simply supported, as well as appropriate reinforcement for restraint forces),
- anchoring of reinforcement of building components stressed primarily in compression (Figure 4, Annex 2),
- anchoring of reinforcement to cover the line of acting tensile force (Figure 5, Annex 2).

The post-installed rebar connections may be installed in dry or wet concrete and it must not be installed in flooded holes. The post-installed rebar connections may be used overhead.

The post-installed rebar connections may be used in the temperature range -40°C to $+80^{\circ}\text{C}$ (max. short term temperature $+80^{\circ}\text{C}$ and max. long term temperature $+50^{\circ}\text{C}$).

This ETA covers anchoring in bore holes made with hammer drilling.

The provisions made in this European Technical Approval are based on an assumed intended working life of the product of 50 years. The indications given on the working life cannot be interpreted as a guarantee given by the producer or Approval Body, but are to be regarded only as a means for choosing the right products in relation to the expected economically reasonable working life of the works.

2 Characteristics of product and methods of verification

2.1 Characteristics of product

The post-installed rebar connections correspond to the drawings and provisions given in Annexes 1 to 12. The characteristic material values, dimensions and tolerances not indicated in Annexes shall correspond to the respective values laid down in the technical documentation⁶ of this European Technical Approval.

Each mortar cartridge is marked with the identifying mark of the producer and with the trade name. The rebars are either delivered with the mortar cartridges or commercial standard rebars purchased separately.

The two components of the TECFI DGE02 injection mortar are delivered in unmixed condition in cartridges of different sizes: 165 ml to 400 ml and types: two part foil capsules in one cartridge (CIC), coaxial or side by side, in accordance with Annex 5.

2.2 Methods of verification

The assessment of fitness of the post-installed rebar connections for the intended use in relation to the requirements for mechanical resistance and stability and safety in use in the sense of the Essential Requirements 1 and 4 has been made in accordance with the ETAG 001 Guideline for European Technical Approval of *"Metal anchors for use in concrete"*, Part 1: *"Anchors in general"* and Part 5: *"Bonded anchors"* and EOTA Technical Report TR 023 *"Assessment of post-installed rebar connections"*.

In addition to the specific clauses relating to dangerous substances contained in this European Technical Approval, there may be other requirements applicable to the products falling within its scope (e.g. transposed European legislation and national laws, regulations and administrative provisions). In order to meet the provisions of the Construction Products Directive, these requirements need also to be complied with, when and where they apply.

⁶ The technical documentation of this European Technical Approval is deposited at Instytut Techniki Budowlanej and, as far as relevant for the tasks of the approved body involved in the attestation of conformity procedure, may be handed over only to the approved body involved.

3 Evaluation of Conformity and CE marking

3.1 System of attestation of conformity

The system of attestation of conformity 2 (i) (referred to as system 1) according to Council Directive 89/106/EEC Annex III laid down by the European Commission provides:

(a) Tasks of the manufacturer:

- 1) factory production control,
- 2) further testing of samples taken at the factory by the manufacturer in accordance with a prescribed test plan;

(b) Tasks of the approved body:

- 1) initial type-testing of the product,
- 2) initial inspection of factory and of factory production control,
- 3) continuous surveillance, assessment and approval of factory production control.

3.2 Responsibilities

3.2.1 Tasks of the manufacturer; factory production control

The manufacturer has a factory production control system in the plant and shall exercise permanent internal control of production. All the elements, requirements and provisions adopted by the manufacturer are documented in a systematic manner in the form of written policies and procedures. This production control system ensures that the product is in conformity with the European Technical Approval.

The manufacturer shall only use raw materials supplied with the relevant inspection documents as laid down in the control plan⁷. The incoming raw materials shall be subject to controls and tests by the manufacturer before acceptance. Check of incoming materials such as nuts, washers, threaded rods, resin, hardeners shall include control of the inspection documents presented by suppliers (comparison with nominal values) by verifying dimensions and determining material properties.

The frequency of controls and tests conducted during production is laid down in the control plan⁷ taking account of the automated manufacturing process.

The results of factory production control are recorded and evaluated. The records include at least the following information:

- designation of the product, basic material and components,
- type of control or testing,
- date of manufacture of the product and date of testing of the product or basic material or components,
- result of control and testing and, if appropriate, comparison with requirements,
- signature of person responsible for factory production control.

The records shall be presented to the approved body involved in continuous surveillance. On request, they shall be presented to Instytut Techniki Budowlanej.

⁷ The control plan has been deposited at Instytut Techniki Budowlanej and may be handed over only to the approved body involved in the attestation of conformity procedure.

Details of the extent, nature and frequency of testing and controls to be performed within the factory production control shall correspond to the control plan⁷ which is part of the technical documentation of this European Technical Approval.

3.2.2 Tasks of the approved body

3.2.2.1 Initial type-testing of the product

For initial type-testing the results of the tests performed as part of the assessment for the European Technical Approval shall be used unless there are changes in the production line or plant. In such cases the necessary initial type-testing has to be agreed between the Instytut Techniki Budowlanej and the approved body involved.

3.2.2.2 Initial inspection of factory and of factory production control

The approved body shall ascertain that, in accordance with the control plan⁷, the factory, in particular the staff and equipment, and the factory production control are suitable to ensure continuous and orderly manufacturing of the anchor according to the specifications mentioned in clause 2.1 as well as to the Annexes to this European Technical Approval.

3.2.2.3 Continuous surveillance

Continuous surveillance and assessment of factory production control have to be performed according to the control plan⁷.

The approved body shall visit the factory at least once a year for surveillance. It has to be verified that the system of factory production control and the specified automated manufacturing process are maintained taking account of the control plan⁷.

The results of continuous surveillance shall be made available on demand by the approved body to Instytut Techniki Budowlanej. In cases where the provisions of the European Technical Approval and the control plan⁷ are no longer fulfilled the conformity certificate shall be withdrawn.

3.3 CE-marking

The CE marking shall be affixed on each packaging of the injection mortar. The letters "CE" shall be accompanied by the following information:

- name and address of the holder of the approval,
- identification number of the approved body,
- last two digits of the year in which the CE marking was affixed,
- number of the EC certificate of conformity,
- number of the European Technical Approval,
- number of the guideline for the European Technical Approval.

4 Assumptions under which the fitness of the product for the intended use was favourably assessed

4.1 Manufacturing

The products are manufactured in accordance with the provisions of the European Technical Approval using the automated manufacturing process as identified during

⁷ see page 5

inspection of the manufacturing plant by Instytut Techniki Budowlanej and laid down in the technical documentation.

4.2 Drafting

Rebar connections must be designed in keeping with good engineering practice. Considering the loads to be anchored, design calculations and design drawings must be produced in a way they can be checked. At least the following items must be given in the design drawings:

- grade of concrete strength,
- diameter, drilling technique, concrete cover, spacing and embedment depth of the rebar,
- kind of preparation of the joint between building component being connected including the thickness of concrete layer that has to be removed.

4.3 Rebar connections design

4.3.1 General

The actual position of the reinforcement in the existing structure shall be determined on the basis of the construction documentation and taken into account when designing.

The design of the post-installed rebar connections according to Annex 2 and determination of the internal section forces to be transferred in the construction joint shall be verified in accordance with EN 1992-1-1.

The minimum clear spacing between two post-installed rebars shall be: $a = 40 \text{ mm} \geq 4 \cdot \varnothing$ (according to Annex 3).

4.3.2 Determination of the basic anchorage length

The required basic anchorage length $l_{b,reqd}$ shall be determined in accordance with EN 1992-1-1, clause 8.4.3:

$$l_{b,reqd} = (\varnothing / 4) \cdot (\sigma_{sd} / f_{bd})$$

where:

\varnothing = diameter of the rebar

σ_{sd} = calculated design stress of the rebar

f_{bd} = design value of bond strength according to Annex 3, Table 2

in consideration of the coefficient related to the quality of bond conditions and of the coefficient related to the rebar diameter

4.3.3 Determination of the design anchorage length

The required design anchorage length l_{bd} shall be determined in accordance with EN 1992-1-1, clause 8.4.4:

$$l_{bd} = \alpha_1 \cdot \alpha_2 \cdot \alpha_3 \cdot \alpha_4 \cdot \alpha_5 \cdot l_{b,rqd} \geq l_{b,min}$$

where: $\alpha_1, \alpha_2, \alpha_3, \alpha_4, \alpha_5$ determined acc. to EN 1992-1-1, Table 8.2:

$\alpha_1 = 1,0$ for straight rebars

$\alpha_2 = 0,7 \leq \alpha_2 \leq 1,0$ calculated acc. to EN 1992-1-1, Table 8.2

$\alpha_3 = 1,0$ because no transverse reinforcement

$\alpha_4 = 1,0$ because no transverse reinforcement

$\alpha_5 = 0,7 \leq \alpha_5 \leq 1,0$ influence of transverse pressure acc. to EN 1992-1-1, Table 8.2

with:

$l_{b,rqd} =$ according to clause 4.3.2

$l_{b,min} =$ minimum anchorage length acc. to EN 1992-1-1, equations 8.6 and 8.7 modified with TR 023, § 4.2

$$l_{b,min} = 1,5 \cdot \max \{0,3 \cdot l_{b,rqd}; 10 \varnothing; 100 \text{ mm}\} \text{ under tension}$$

$$l_{b,min} = 1,5 \cdot \max \{0,6 \cdot l_{b,rqd}; 10 \varnothing; 100 \text{ mm}\} \text{ under compression}$$

The maximum anchorage depth is given in Annex 3, Table 1.

4.3.4 Overlap joints

The required design anchorage length l_0 shall be determined in accordance with EN 1992-1-1, clause 8.7.3:

$$l_0 = \alpha_1 \cdot \alpha_2 \cdot \alpha_3 \cdot \alpha_5 \cdot \alpha_6 \cdot l_{b,rqd} \geq l_{0,min}$$

where: $\alpha_1, \alpha_2, \alpha_3, \alpha_5, \alpha_6$ determined acc. to EN 1992-1-1, Tables 8.2 and 8.3 with:

$\alpha_1 = 1,0$ for straight rebars

$\alpha_2 = 0,7 \leq \alpha_2 \leq 1,0$ calculated acc. to EN 1992-1-1, Table 8.2

$\alpha_3 = 1,0$ because no transverse reinforcement

$\alpha_5 = 0,7 \leq \alpha_5 \leq 1,0$ influence of transverse pressure acc. to EN 1992-1-1, Table 8.2

$\alpha_6 = 1,0 \leq \alpha_6 \leq 1,5$ influence of percentage of lapped bars relative to the total cross-section area acc. to EN 1992-1-1, Table 8.3

with:

$l_{b,rqd} =$ according to clause 4.3.2.

$l_{0,min} =$ minimum lap length acc. to EN 1992-1-1, equation 8.11 modified with TR 023, § 4.2

$$l_{0,min} = 1,5 \cdot \max \{0,3 \alpha_6 l_{b,rqd}; 15 \varnothing; 200 \text{ mm}\}$$

The maximum anchorage depth is given in Annex 3, Table 1.

4.3.5 Embedment depth for overlap joints

For the calculation of the effective embedment depth of overlap joints the concrete cover at end-face of bonded-in rebar c_1 shall be considered:

$$l_v \geq l_0 + c_1$$

where:

l_0 = required lap length acc. to clause 4.3.4 and EN 1992-1-1

c_1 = concrete cover at end-face of bonded-in rebar

If the clear distance between overlapping rebars is greater than $4 \varnothing$ the overlap length shall be enlarged by the difference between the clear distance and $4 \varnothing$.

4.3.6 Concrete cover

The concrete cover required for bonded-in rebars is shown in Annex 3.

Furthermore the minimum concrete cover given in EN 1992-1-1, clause 4.4.1.2 shall be observed.

4.3.7 Transverse reinforcement

The requirements of transverse reinforcement in the area of the post-installed rebar connection shall comply with EN 1992-1-1, clause 8.7.4.

4.3.8 Connection joint

The transfer of shear forces between new concrete and existing structure shall be designed according to EN 1992-1-1. The joints for concreting shall be roughened to at least such an extent that aggregate protrude.

In the case of carbonated surface of the existing concrete structure the carbonated layer shall be removed in the area of the post-installed rebar connection with a diameter of $\varnothing + 60$ mm prior to the installation of the new rebar.

The depth of concrete to be removed shall correspond to at least the minimum concrete cover for the respective environmental conditions in accordance with EN 1992-1-1.

The foregoing may be neglected if building components are new and not carbonated and if building components are in dry conditions.

4.4 Installation

The fitness for use of the post-installed rebars can only be assumed if the rebar is installed as follows:

- installation of the post-installed rebars shall be done only by suitable trained installer and under supervision on the site,
- use of the injection system only as supplied by the manufacturer without changing the components,
- installation in accordance with the manufacturer's specifications and drawings using the tools indicated in the technical documentation of this European Technical Approval,
- checks before rebar installation to ensure that the strength class of the concrete in which the post-installed rebar connection is to be placed is in the range given and is not lower than that of the concrete to which the characteristics loads apply,

- check of concrete being well compacted, e.g. without significant voids,
- check the position of the existing rebars,
- keeping the anchorage depth as specified in the design drawings,
- keeping the concrete cover and spacing as specified in the design drawings,
- positioning of the drill holes without damaging the reinforcement,
- in case of aborted drill hole: the drill hole shall be filled with mortar,
- rebar installation ensuring the specified embedment depth, that is the appropriate depth marking of the rebar not exceeding the concrete surface,
- clearing the hole of drilling dust: the hole shall be cleaned by at least four blowing operations, by at least four brushing operations followed again by at least four blowing operations, before brushing cleaning the brush and checking whether the brush diameter according to Annex 6 and 7 is sufficient,
- mortar injection by using the equipment including the special mixing nozzle (mixer) shown in Annex 5 and 9; discarding the first swings of mortar of each new cartridge until an homogeneous color is achieved; taking from the manufacturer instruction the admissible processing time (open time) of a cartridge as a function of the ambient temperature of the concrete; filling the drill hole uniformly from the drill hole bottom, in order to avoid entrapment of air; removing the special mixing nozzle slowly bit by bit during pressing-out; filling the drill hole with a quantity of the injection mortar corresponding to 2/3 of the drill hole depth; inserting immediately the rebar, slowly and with a slight twisting motion, removing excess of injection mortar around the rod; observing the loading (curing) time according to Annex 4, Table 5 until the rebar may be loaded;
- components installation temperature shall be at least +5°C,
- during installation and curing of the injection mortar the temperature of the building component must not be less than +5°C and no more than +30°C, observing the curing time given in Annex 4.

4.4.1 Responsibility of the manufacturer

It is the manufacturer's responsibility to ensure that the information on the specific conditions according to clause 1 and 2 including Annexes referred to clause 4 is given to those who are concerned. This information may be made by reproduction of the respective parts of the European Technical Approval. In addition all installation data shall be shown clearly on the package and/or on an enclosed instruction sheet, preferably using illustration(s).

The minimum data required are:

- drill bit diameter,
- diameter of rebar,
- admissible service temperature range,
- curing time of the injection mortar depending on the installation temperature,
- information on the installation procedure, including cleaning of the drill hole, preferably by means of an illustration,
- reference to any special installation equipment needed,
- identification of the manufacturing batch.

All the data shall be presented in a clear and explicit form.

5 Recommendations on packaging, transport and storage

The mortar cartridges shall be protected against sun radiation and shall be stored according to the manufacturer's instructions in dry conditions at temperatures of at least +5°C to not more than +30°C.

Mortar cartridges with expired shelf life must no longer be used.

On behalf of Instytut Techniki Budowlanej



Marek Kaproń
Director of ITB

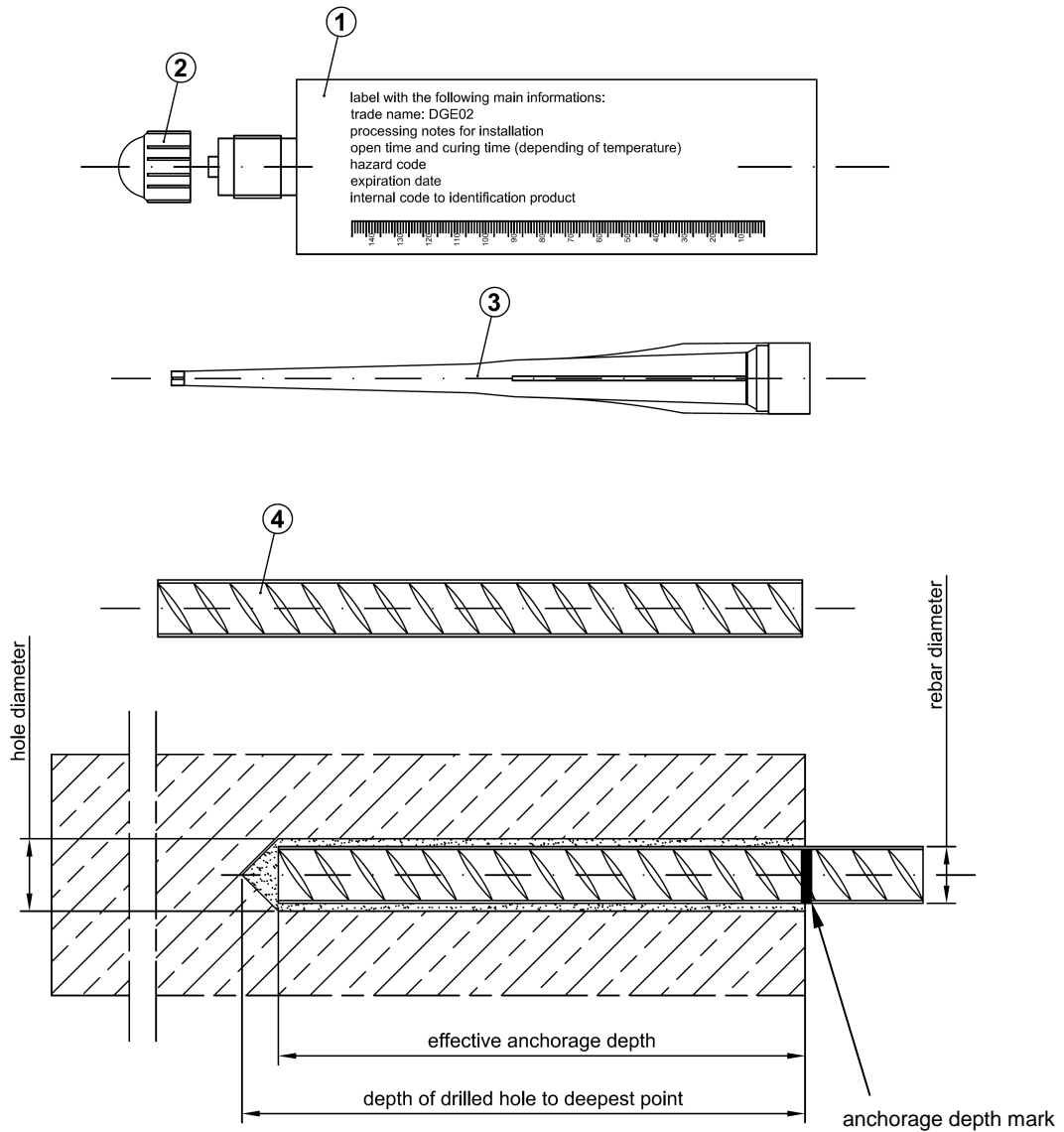

- 1 – cartridge DGE02
- 2 – sealing cap
- 3 – mixer
- 4 – rebar (reinforcing bar)

Covered are post-installed rebar connections in non-carbonated concrete on the assumption only that the design of post-installed rebar connections is done in accordance to EN 1992-1-1 (Eurocode 2).

Installation in dry or wet concrete, it must not be installed in flooded holes. Overhead installation is permissible.

Temperature range: -40°C to +80°C (max. short term temperature +80°C and max. long term temperature +50°C).

TECFI DGE02 for rebar connections	Annex 1 of European Technical Approval ETA-10/0103
Product description and intended use	

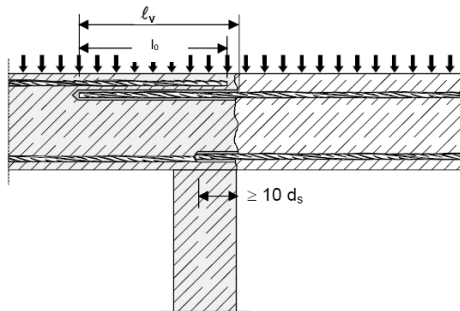

Figure 1: Overlap joint for rebar connections of slabs and beams

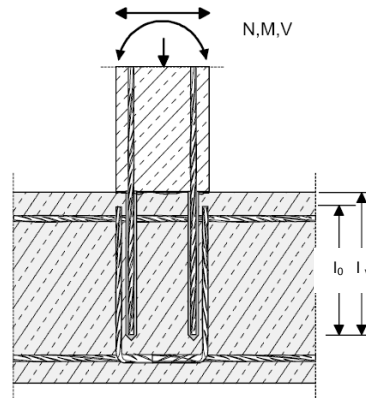

Figure 2: Overlap joint at a foundation of a column or wall where the rebars are stressed in tension

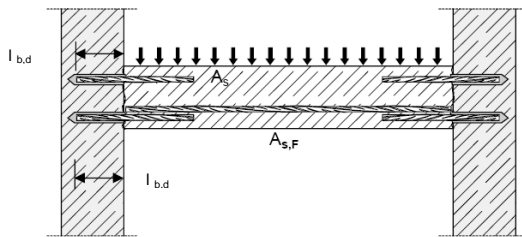

Figure 3: End anchoring of slabs or beams, designed as simply supported

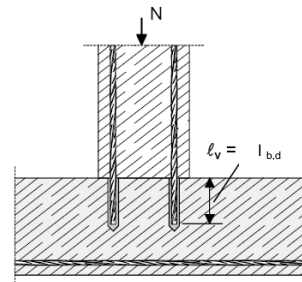

Figure 4: Rebar connection for components stressed primarily in compression. The rebars are stressed in compression

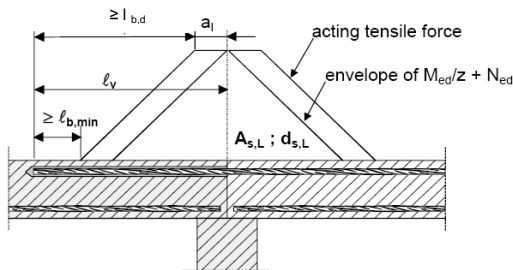

Figure 5: Anchoring of reinforcement to cover the line of acting tensile force

Note to Figure 1 to 5:

In the Figures no transverse reinforcement is plotted, the transverse reinforcement as required by EC 2 shall be present.

The shear transfer between old and new concrete shall be designed according to EC 2.

TECFI DGE02 for rebar connections

Intended use

Annex 2
 of European
 Technical Approval
 ETA-10/0103

Table 1: Dimensions and installation parameters*

Rebar diameter [mm]	Ø8	Ø10	Ø12	Ø14	Ø16	Ø20	Ø25	Ø28	Ø32
Drill bit diameter [mm]	12	14	16	18	20	25	30	35	40
Brush diameter [mm]	14	16	18	20	22	27	32	37	42
Minimum anchorage depth $l_{b,min}$ [mm]	175	215	260	300	345	430	535	600	685
Minimum anchorage depth: overlap joint $l_{o,min}$ [mm]	300	300	300	315	360	450	565	630	720
Maximum anchorage depth $l_{v,max}$ [mm]	400	500	600	700	800	1000	1000	1000	1000

* Table 8 "Tools for installation" also should be taken into account

Minimum anchorage length for anchoring rebar: $l_{b,min} = 1.5 \cdot \max \{0,3 \cdot l_{b,rqd}; 10 \varnothing; 100 \text{ mm}\}$

Minimum lap length for overlap joint: $l_{o,min} = 1.5 \cdot \max \{0,3 \alpha_6 l_{b,rqd}; 15 \varnothing; 200 \text{ mm}\}$

Table 2: Design values of the ultimate bond resistance f_{bd} according to EN 1992-1-1

Rebar diameter [mm]	Ultimate bond resistance f_{bd}^* [N/mm ²]								
	C12/15	C16/20	20/25	C25/30	C30/37	C35/45	C40/50	C45/55	C50/60
Ø8	1,60	2,00	2,30	2,70	3,00	3,40	3,70	4,00	4,30
Ø10	1,60	2,00	2,30	2,70	3,00	3,40	3,70	4,00	4,30
Ø12	1,60	2,00	2,30	2,70	3,00	3,40	3,70	4,00	4,30
Ø14	1,60	2,00	2,30	2,70	3,00	3,40	3,70	4,00	4,30
Ø16	1,60	2,00	2,30	2,70	3,00	3,40	3,70	4,00	4,00
Ø20	1,60	2,00	2,30	2,70	3,00	3,40	3,70	4,00	4,00
Ø25	1,60	2,00	2,30	2,70	3,00	3,40	3,70	3,70	3,70
Ø28	1,60	2,00	2,30	2,70	3,00	3,40	3,40	3,40	3,40
Ø32	1,60	2,00	2,30	2,70	2,70	2,70	2,70	2,70	2,70

* The values given in Table 2 are valid for "good bond condition" as described on EN 1992-1-1. For all other conditions multiply the value by 0,7.

Minimum concrete cover: $c_{min} = 30 + 0,06 l_v \geq 2 \cdot \varnothing$ [mm]

Minimum clear spacing between two post-installed rebars: $a = 40 \text{ mm} \geq 4 \cdot \varnothing$

TECFI DGE02 for rebar connections	Annex 3 of European Technical Approval ETA-10/0103
Rebars dimensions and installation parameters	

Table 3: Rebars according to EN 1992-1-1, Annex C, Tables C.1 and C.2N

Product form		Bars and de-coiled rods	
Class		B	C
Characteristic yield strength f_{yk} or $f_{0,2k}$ [N/mm ²]		400 to 600	
Minimum value of $k = (f_t / f_y)_k$		≥ 1,08	≥ 1,15 < 1,35
Characteristic strain at maximum force, ϵ_{uk} [%]		≥ 5,0	≥ 7,5
Bendability		Bend / Rebend test	
Maximum deviation from nominal mass (individual bar), [%]	Nominal bar size [mm]	± 6.0 ± 4.5	
	≤ 8 > 8		
Bond: minimum relative rib area, $f_{R,min}$	Nominal bar size [mm]	0,040 0,056	
	8 to 12 > 12		

Rib height h: The rib height h should be: $0,05 \cdot \emptyset \leq h \leq 0,07 \cdot \emptyset$
 \emptyset = nominal bar diameter

Table 4: Injection mortar

Product	Composition
TECFI DGE02 two components injection mortar	Additive: quartz Bonding agent: vinyl ester resin styrene free Hardener: dibenzoyl peroxide

Table 5: Minimum curing time¹⁾

Concrete temperature	Processing time [minutes]	Minimum curing time ¹⁾ [hours]
5°C	25	8
10°C	16	4
15°C	11,5	3
20°C	7,5	2
25°C	5	1,5
30°C	3	1

¹⁾ the minimum time from the end of the mixing to the time when the anchor may be torque or loaded (whichever is longer)

TECFI DGE02 for rebar connections	Annex 4 of European Technical Approval ETA-10/0103
Materials and curing time	

DGE02 - 400 ml cartridge - coaxial cartridge

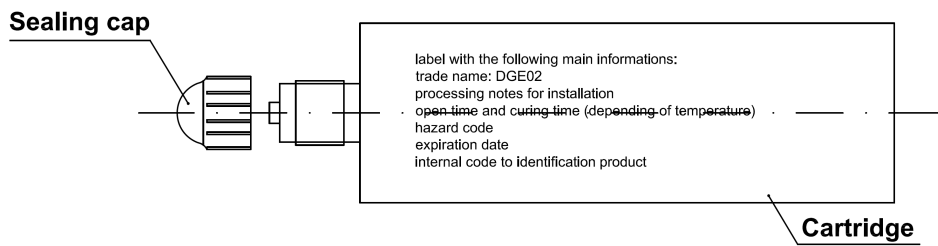

DGE02 - 345 ml cartridge - side by side cartridge

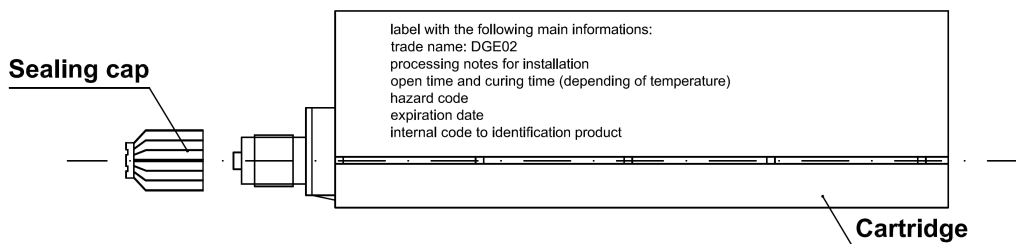

DGE02 - 300 ml and 165 ml cartridge - foil cartridge

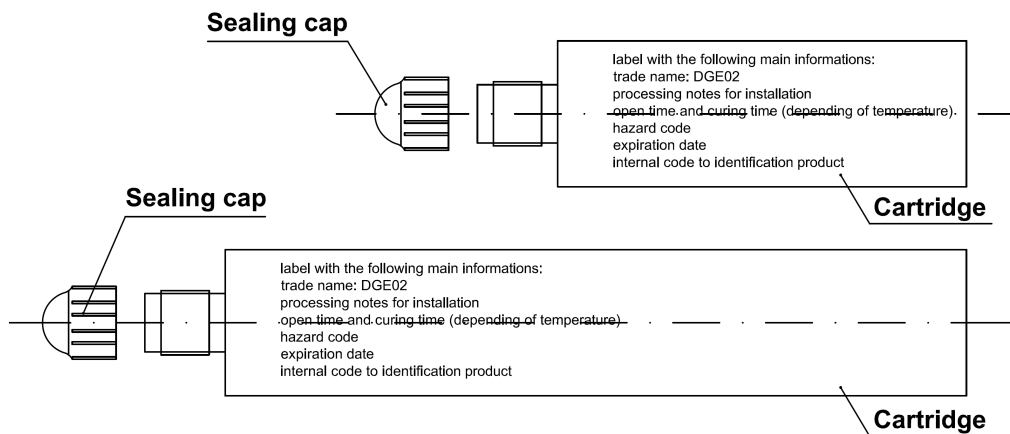

MIXER - the mixer is suitable for each type of cartridge

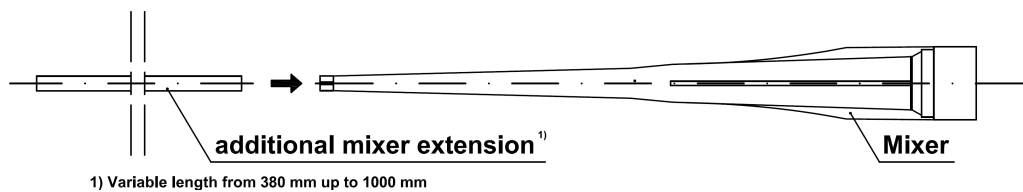

TECFI DGE02 for rebar connections

Cartridges and mixer

Annex 5
 of European
 Technical Approval
 ETA-10/0103

Manual Blower pump: nominal dimensions

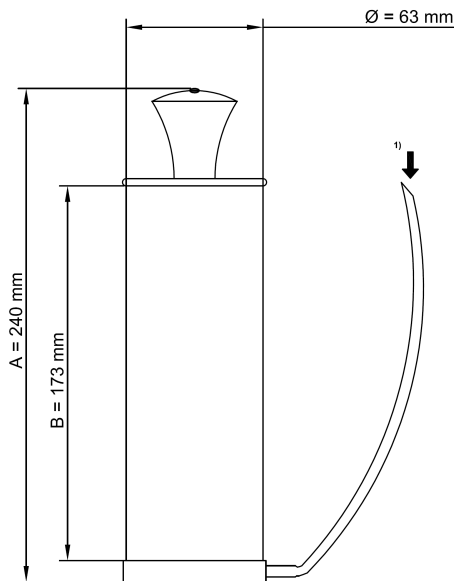

It is possible to use the mixer extension (see Annex 5) with the manual blower pump.

However it is possible to blow the hole using the mechanical air system (compressed air) also with the mixer extension



Suitable min pressure 6 bar at 6 m³/h
 Oil-free compressed air
 Recommended air gun with an orifice opening of minimum 3.5 mm in diameter

1) Position to insert the mixer extension

Standard brush

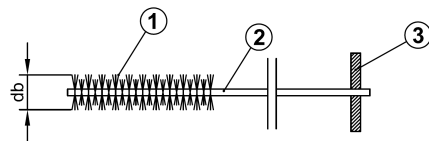

- ① Steel bristles
- ② Steel stem
- ③ Wood handle

Table 6: Standard brush details (manual brush)

Rebar diameter [mm]			Ø8	Ø10	Ø12	Ø14
d ₀	Nominal drill hole	[mm]	12	14	16	18
d _b	Brush diameter	[mm]	14	16	18	20

The use of standard brush is recommended according to the Table 8

TECFI DGE02 for rebar connections

Cleaning tools (1)

Annex 6
 of European
 Technical Approval
 ETA-10/0103

Special brush

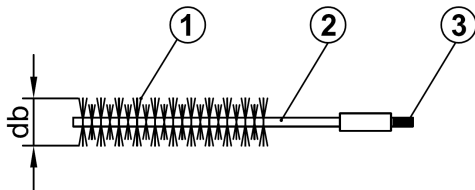

- ① Steel bristles
- ② Steel stem
- ③ Threaded connection for drilling tool extension
- ④ Extension special brush
- ⑤ Drilling tool connection (SDS connection)

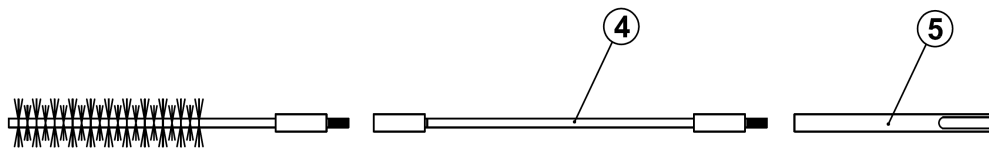







Table 7: Special brush details (mechanical brush)

Rebar diameter [mm]			Ø8	Ø10	Ø12	Ø14	Ø16	Ø20	Ø25	Ø28	Ø32
d_0	Nominal drill hole	[mm]	12	14	16	18	20	25	30	35	40
d_b	Brush diameter	[mm]	14	16	18	20	22	27	32	37	42

The use of special brush is recommended according to the Table 8

TECFI DGE02 for rebar connections	Annex 7 of European Technical Approval ETA-10/0103
Cleaning tools (2)	

Table 8: Tools for installation

Pump	Cartridges	Clean hole tools	Rebar diameter	Maximum depth of the drill hole
 <i>DH 01 00 400 – Manual</i>	400 ml	Blower pump or compressed air and standard brush or special brush	Ø8 to Ø14	315 mm
 <i>DH 01 00 345 – Manual</i>	345 ml 300 ml 165 ml	Blower pump or compressed air and standard brush or special brush	Ø8 to Ø14	315 mm
 <i>DH 01 00 300 – Manual</i>	300 ml 165 ml	Blower pump or compressed air and standard brush or special brush	Ø8 to Ø14	315 mm
 <i>DH 03 00 400 – Pneumatic</i>	400 ml	Blower pump or compressed air and standard brush or special brush	Ø8 to Ø14	315 mm
 <i>DH 03 00 400 – Pneumatic</i>	400 ml	Compressed air and special brush	Ø8 to Ø32	315 mm to 1000 mm*

* Note: use the mixer extension described in Annex 5 and Annex 9 for the injection of the mortar

TECFI DGE02 for rebar connections

Tools for installation

Annex 8
 of European
 Technical Approval
 ETA-10/0103

Tools for installation in special condition

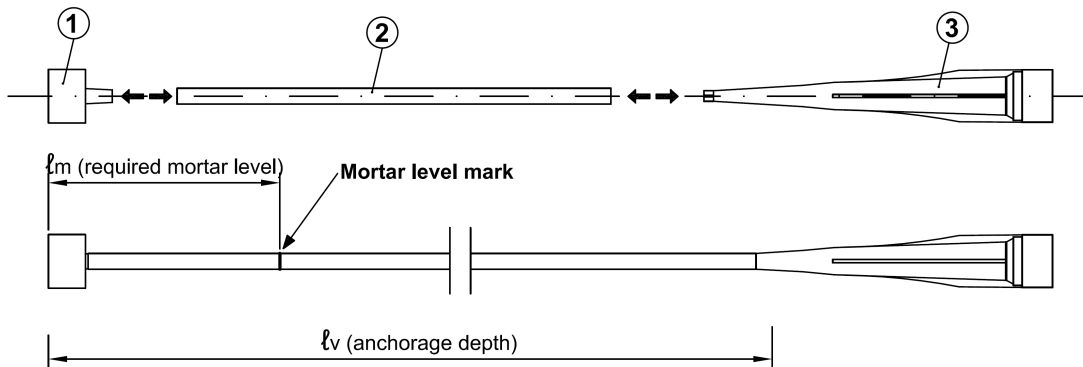

- ① Injection plug (nominal diameter according to the nominal diameter of drilled hole)
- ② Special mixer extension (variable length with external diameter 12 mm)
 Mark the required mortar level l_m and embedment depth l_v with tape or marker on the injection extension. Quick estimation: $l_m = 1/3 \cdot l_v$
 Continue injection until the mortar level mark l_m becomes visible.
- ③ Special short mixer (suitable for all size of cartridge)

These tools allow the application in special conditions:

- installation with anchorage depth greater than 315 mm (see table 8);
- overhead installation.

For these applications is recommended the use of the injection pneumatic pump.

System assembled

- 1 – Injection plug
- 2 – Special mixer extension
- 3 – Special short mixer
- 4 – DGE02 cartridge
- 5 – Sample of injection pneumatic pump

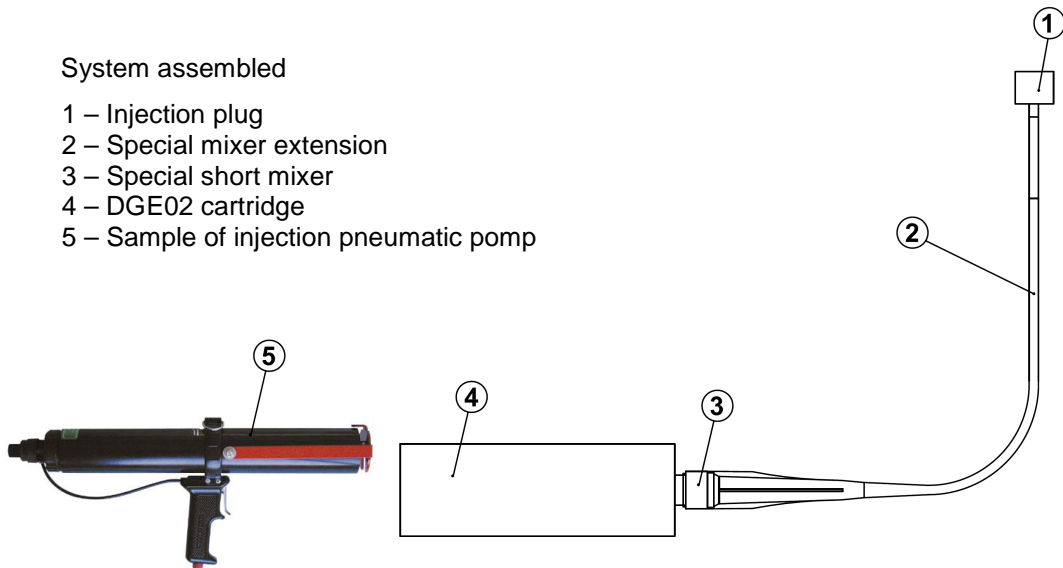





TECFI DGE02 for rebar connections

Special installation conditions

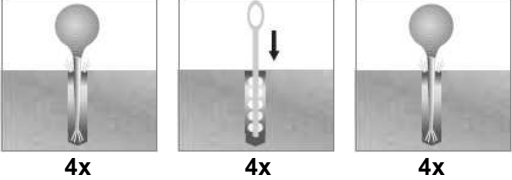
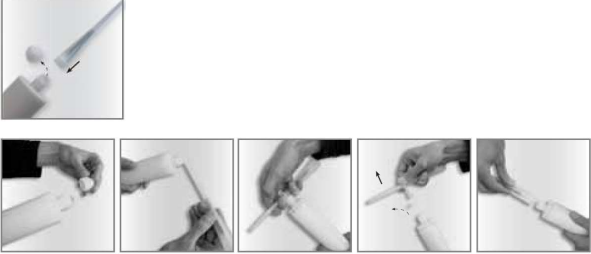
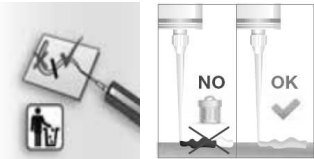
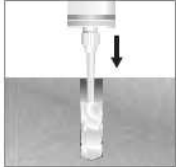
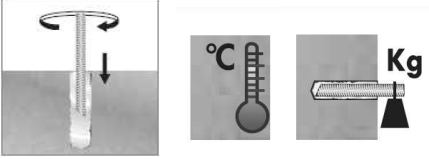
Annex 9

of European
 Technical Approval
 ETA-10/0103

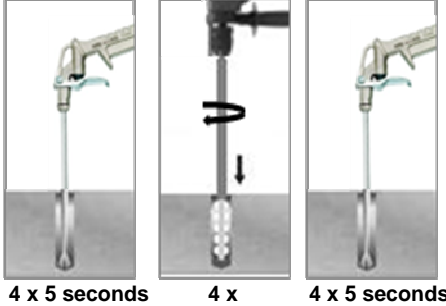
<p>1</p>		<p>Drill the hole with the correct diameter and depth (Annex 3, Table 1) using a rotary percussive machine. Check the perpendicularity of the hole during the drilling operation.</p>
<p><i>Suitable installation tools for different applications are detailed in Annex 8, Table 8.</i></p>		
<p>2</p>		<p>Clean the hole from drilling dust: the hole shall be cleaned by at least 4 blowing operations, by at least 4 brushing operations followed again by at least 4 blowing operations; before brushing clean the brush and check if the brush diameter is sufficient (according to Annex 6, Table 6 and Annex 7, Table 7). For the blower tools see Annex 6.</p>
<p>3</p>		<p>For sizes 400 ml and 345 ml unscrew the front cup, screw on the mixer and insert the cartridge in the gun. For the size 300 ml and 165 ml, unscrew the front cup, pull-out the steel closing clip according to the following operations:</p> <ul style="list-style-type: none"> - insert the mixer in the eye of the plastic extractor, - pull the extractor to unhook the steel closing clip of the foil. <p>After that, screw on the mixer and insert the cartridge in the gun.</p>
<p>4</p>		<p>Before starting to use the cartridge, eject a first part of the product, being sure that the two components are completely mixed. The complete mixing is reached only after that the product, obtained by mixing the two component, comes out from the mixer with an uniform color.</p>
<p>5</p>		<p>Fill the drilled hole uniformly starting from the drilled hole bottom, in order to avoid entrapment of the air; remove the mixer slowly bit by bit during pressing-out; filling the drill hole with a quantity of the injection mortar corresponding to 2/3 of the drill hole depth.</p>
<p>6</p>		<p>Insert immediately the rebar, marked according to Annex 1, slowly and with a slight twisting motion, removing excess of injection mortar around the rebar. The processing time and the curing time according to Annex 4, Table 5 should be taken into account.</p>
<p>TECFI DGE02 for rebar connections</p>		<p>Annex 10</p>
<p>Installation procedure I (up to 315 mm anchorage depth)</p>		<p>of European Technical Approval ETA-10/0103</p>

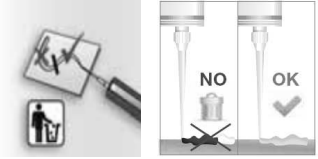
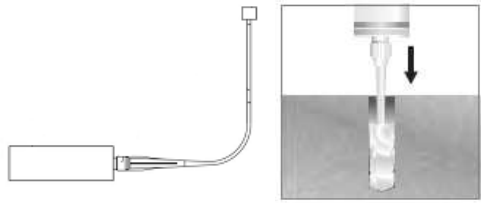
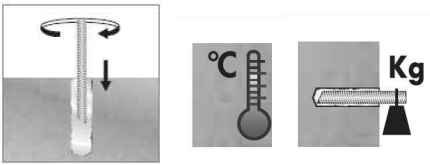
<p>1</p>		<p>Drill the hole with the correct diameter and depth (Annex 3, Table 1) using a rotary percussive machine. Check the perpendicularity of the hole during the drilling operation.</p>
<p><i>Suitable installation tools for different applications are detailed in Annex 8, Table 8.</i></p>		
<p>2</p>		<p>Clean the hole from drilling dust: the hole shall be cleaned by at least 4 blowing operations (5 seconds for single operation) with compressed air, by at least 4 brushing operations with special brush followed again by at least 4 blowing operations (5 seconds for single operation) with compressed air. Before brushing clean the brush and check (according to Annex 7, Table 7) if the brush diameter is sufficient. For the blower tools see Annex 6.</p>
<p>3</p>		<p>Unscrew the front cup of the 400 ml size cartridge, screw on the mixer and insert the cartridge in the pneumatic-gun.</p>
<p>4</p>		<p>Before starting to use the cartridge, eject a first part of the product, being sure that the two components are completely mixed. The complete mixing is reached only after that the product, obtained by mixing the two component, comes out from the mixer with an uniform color.</p>
<p>5</p>		<p>Before starting the injection, assemble the system according to Annex 9. After that, fill the drilled hole uniformly from the drilled hole bottom, in order to avoid entrapment of the air; remove the special mixer extension with injection plug slowly bit by bit during pressing-out; filling the drill hole with a quantity of the injection mortar corresponding to 2/3 of the drill hole depth. Procedure for overhead installation are detailed in Annex 12.</p>
<p>6</p>		<p>Insert immediately the rebar, marked according to Annex 1, slowly and with a slight twisting motion, removing excess of injection mortar around the rebar. Observe the processing time according to Annex 4, Table 5. Wait the curing time according to Annex 4, Table 5.</p>
<p>TECFI DGE02 for rebar connections</p>		<p>Annex 11</p>
<p>Installation procedure II (up to 1000 mm anchorage depth)</p>		<p>of European Technical Approval ETA-10/0103</p>

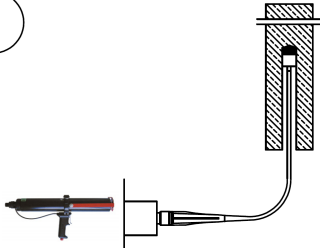
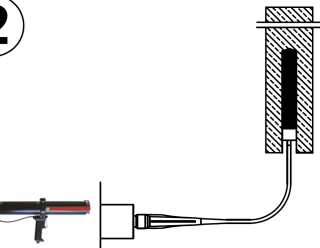
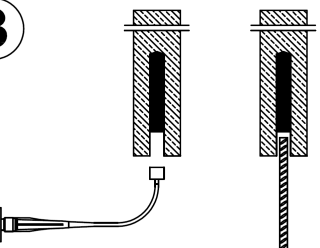
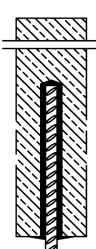
<p>1</p> 	<p>1 - Start injection</p> <p>Inject from the bottom of the hole. Maintain this position during the injection phase.</p>
<p>2</p> 	<p>2 - Injection phase</p> <p>Inject the product about 2/3 of the hole depth. During the injection maintain this position to assure the correct installation</p>
<p>3</p> 	<p>3 - End injection</p> <p>Remove the injection plug. Insert immediately the rebar (turn the rebar during the insertion).</p>
<p>4</p> 	<p>4 - End installation</p> <p>To avoid the slipping of the rebar during the open time of the product (due to the rebar own weight) use a temporary interlocking element (for ex. wedge of wood)</p>

TECFI DGE02 for rebar connections

Overhead installation instruction

Annex 12
 of European
 Technical Approval
 ETA-10/0103